



---

# DVD Player with Remote Control

## OWNER'S MANUAL

# SB329

Copyright 2004 Viacom International Inc. All Rights Reserved. Nickelodeon, SpongeBob SquarePants and all related titles, logos and characters are trademarks of Viacom International Inc. Created by Stephen Hillenburg.



## Welcome.....

Emerson Radio Corp. has produced this audio/video product under license from Nickelodeon. We have taken great care to make sure your unit was in perfect working order when it left our factory.

Thank you for purchasing this Compact Audio/Video System. This state of the art system includes everything you need to experience digital video and audio in the comfort of your own living room. The only thing you need to add is your own TV. We have designed this system to be easy to set up, and even easier to use. But please, review this manual before you operate your system. Have it handy while you are setting the system up. Keep it available for future reference in the unlikely event that you encounter any unexpected problems. The manual begins with a description of the important controls on the main unit and the remote. It then explains how to connect your TV, and how to operate the DVD/CD player. If you follow the instructions carefully you can have the system up and operating in less than an hour.

All of the optional system settings have been preset at our factory for correct operation of the system in North America. All you have to do is insert a disk, sit back, and enjoy a great audio/video experience.

Eventually you may want to change some of the optional settings. A description of all the optional settings, and instructions for changing them, is found in the second half of the manual.

This system was designed to provide you with many years of reliable operation with a minimum of care and maintenance. Every component in your system was in perfect working condition when it left our factory. If you experience any problems with the set up or operation of this system please review the Trouble Shooting Guide at the end of this manual before you contact your dealer or the Emerson Customer Service Department.

## Warning

**To prevent fire or shock hazard, do not expose the unit to rain or moisture.**

**To avoid electrical shock, do not open the cabinet.**

**Refer servicing to qualified service personnel only.**

**The AC cord must only be changed at qualified service facility.**

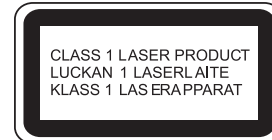

- This appliance is classified as a CLASS 1 LASER product.
- The CLASS 1 LASER PRODUCT MARKING is located on the rear panel.
- This product contains a low power laser device. To ensure continued safety, do not remove any cover or attempt to again access to the inside of the product. Refer all servicing to qualified personnel only.

This product incorporates copyright protection technology that is protected by method claims of certain U.S. patents and other intellectual property rights owned by Macrovision Corporation and other rights owners. Use of this copyright protection technology must be authorized by Macrovision Corporation, and is intended for home and other limited viewing uses only unless otherwise authorized by Macrovision Corporation. Reverse engineering or disassembly is prohibited.

Apparatus Claims of U.S. Patent Nos. 4,631,603, 4,819,098, 4,907,093, 5,315,448 and 6,516,132 licensed for limited viewing uses only.

## Caution

**Refer servicing to qualified service personnel only.**

The rating label and caution marking is located at the bottom of the unit.

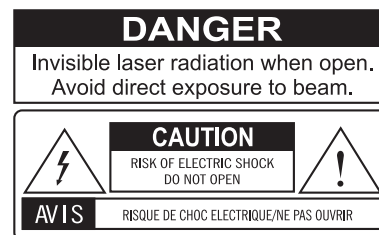

This symbol is intended to alert the user of the presence of uninsulated "dangerous voltage" within the product enclosure that may be of sufficient magnitude to constitute a risk of electric shock to persons.



This symbol is intended to alert the user to the presence of important operating and maintenance (servicing) instructions in the literature accompanying the appliance.



The symbol for class II (Double insulation)





# IMPORTANT SAFETY INSTRUCTIONS

Before using the unit, be sure to read all operating instructions carefully. Please note that these are general precautions and may not pertain to your unit. For example, this unit may not have the capability to be connected to an outdoor antenna.

## 1. READ INSTRUCTIONS

All the safety and operating instructions should be read before the product is operated.

## 2. RETAIN INSTRUCTIONS

The safety and operating instruction should be retained for future reference.

## 3. HEED WARNINGS

All warning on the product and in the operating instructions should be adhered to.

## 4. FOLLOW INSTRUCTIONS

All operating and use instructions should be followed.

## 5. CLEANING

Unplug this product from the wall outlet before cleaning. Do not liquid cleaners or aerosol cleaners. Use a damp cloth for cleaning.

## 6. ATTACHMENTS

Do not use attachments not recommended by the product's manufacturer as they may cause hazards.

## 7. WATER AND MOISTURE

Do not use this product near water- for example, near a bathtub, washbowl, kitchen sink, or laundry tub, in a wet basement, or near a swimming pool.

## 8. ACCESSORIES

Do not place this product on an unstable cart, stand, tripod, bracket, or table. The product may fall, causing serious injury and serious damage to the product. Use only with a cart, stand, tripod, bracket, or table recommended by the manufacturer or sold with the product. Any mounting of the product should follow the manufacturer's instructions, and should use a mounting accessory recommended by the manufacturer.



8A. An appliance and cart combination should be moved with care. Quick stops, excessive force, and uneven surface may cause the appliance and cart combination to overturn.

## 9. VENTILATION

Slots and openings in the cabinet and in the back or bottom of the cabinet are provided for ventilation and to ensure reliable operation of the product and to protect it from overheating. These openings must not be blocked or covered. The openings should never be blocked by placing the product on a bed, sofa, rug, or other similar surface. This product should never be placed near or over a radiator or heat source. This product should not be placed in a built-in installation such as a bookcase or rack unless proper ventilation is provided or the manufacturer's instructions have been adhered to.

## 10. POWER SOURCES

This product should be operated only from the type of power source indicated on the marking label. If you are not sure of the type of power supply to your home, consult your appliance dealer or local power company. For products intended to operate from battery power, or other sources, refer to the operating instruction.

## 11. GROUNDING OR POLARIZATION

This product is equipped with an alternating-current line plug (a plug having one blade wider than the other). This plug will fit into the power outlet only one way. This is a safety feature. If you are unable to insert the plug fully into the outlet, try reversing the plug. If the plug should still fail to fit, contact your electrician to replace your obsolete outlet.

Do not defeat the safety purpose of the polarized plug.

## 12. POWER-CORD PROTECTION

Power-supply cords should be routed so that they are not likely to be walked on or pinched by items placed upon or against them, paying particular attention to cords at plugs, convenience receptacles, and the point where they exit from the appliance.

## 13. LIGHTNING

To protect your product from a lightning storm, or when it is left unattended and unused for long periods of time, unplug it from the wall outlet and disconnect the antenna or cable system. This will prevent damage to the product due to lightning and power-line surges.

## 14. POWER LINES

An outside antenna system should not be located in the vicinity of overhead power lines or other electric light or power circuits, or where it can fall into such powerlines or circuits. When installing an outside antenna system, extreme care should be taken to keep from touching such power lines or circuits as contact with them might be fatal.

# IMPORTANT SAFETY INSTRUCTIONS (CONTINUED)

## 15. OVERLOADING

Do not overload wall outlets and extension cords as this can result in a risk of fire or electric shock.

## 16. OBJECT AND LIQUID ENTRY

Never push objects of any kind into this product through openings as they may touch dangerous voltage points or short out parts that could result in fire or electric shock. Never spill or spray any type of liquid on the product.

## 17. OUTDOOR ANTENNA GROUNDING

If an outside antenna is connected to the product, be sure the antenna system is grounded so as to provide some protection against voltage surges and built-up static charges. Section 810 of the National Electric Code, ANSI/NFPA 70, provides information with respect to proper grounding of the mast and supporting structure, grounding of the lead-in wire to an antenna discharge product, size of grounding conductors, location of antenna discharge product, connection to grounding electrodes, and requirements for grounding electrode.

## 18. SERVICING

Do not attempt to service this product yourself as opening or removing covers may expose you to dangerous voltage or other hazards. Refer all servicing to qualified service personnel.

## 19. REPLACEMENT PARTS

When replacement parts are required, be sure the service technician uses replacement parts specified by the manufacturer or those that have the same characteristics as the original part. Unauthorized substitution may result in fire, electric shock or other hazards.

## 20. SAFETY CHECK

Upon completion of any service or repairs to this product, ask the service technician to perform safety checks to determine that the product is in proper operating condition.

## 21. WALL OR CEILING MOUNTING

The product should be mounted to a wall or ceiling only as recommended by the manufacturer.

## 22. DAMAGE REQUIRING SERVICE

Unplug the product from the wall outlet and refer servicing to qualified service personnel under the following conditions:

- When the power-supply cord or plug is damaged.
- If liquid has been spilled, or objects have fallen into the product.
- If the product has been exposed to rain or water.
- If the product does not operate normally by following the operating instructions. Adjust only those controls that are covered by the operating instructions, as an adjustment of other controls may result on damage and will often require extensive work by a qualified technician to restore the product to its normal operation.
- If the product has been dropped or the cabinet has been damaged.
- When the product exhibits a distinct change in performance - this indicates a need for service.

## 23. HEAT

The product should be situated away from heat sources such as radiators, heat registers, stoves, or other products (including amplifiers) that produce heat.

## 24. NOTE TO CATV SYSTEM INSTALLER

This reminder is provided to call the CATV system installer's attention to Article 820-40 of NEC that provides guidelines for proper grounding and, in particular, specifies that the cable ground shall be connected to the grounding system of the building, as close to the point of cable entry as practical.

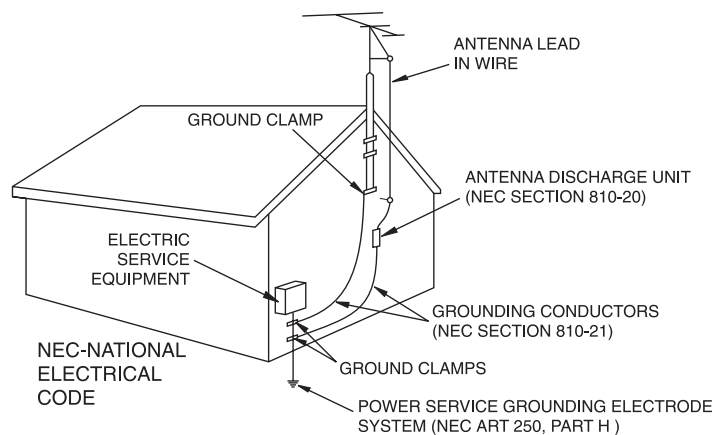



## IMPORTANT SAFETY INSTRUCTIONS (CONTINUED)

Any use of the controls or an adjustment to the procedures other than those specified herein may result in hazardous radiation. TO REDUCE THE RISK OF ELECTRIC SHOCK, DO NOT REMOVE COVER (OR BACK). THERE ARE NO USER-SERVICEABLE PARTS INSIDE. PLEASE REFER ANY SERVICING TO QUALIFIED SERVICE PERSONNEL.

**WARNING:** Changes or modifications to this unit not expressly approved by the party responsible for compliance could void the user's authority to operate the equipment.

### FCC NOTICE:

This equipment has been tested and found to comply with the limits for a Class B digital device, pursuant to part 15 of the FCC Rules. These limits are designed to provide reasonable protection against harmful interference in a residential installation. This equipment generates, uses, and can radiate radio frequency energy and, if not installed and used in accordance with the instructions, may cause harmful interference to radio communications.

However, there is no guarantee that interference will not occur in a particular installation. If this equipment does cause harmful interference to radio or television reception, which can be determined by turning the equipment off and on, the user is encouraged to try to correct the interference by one or more of the following measures:

- Consult the dealer or an experienced radio/TV technician for help.

### FCC CAUTION:

To assure continued compliance, follow the attached installation instructions and use only shielded cables when connecting to other devices. Also, any changes or modifications not expressly approved by the party responsible for compliance could void the user's authority to operate the equipment.



# Table of Contents

## Warnings and Cautions

Welcome .....	1
UL Safety Instructions .....	1-3
FCC Notice .....	4
FCC Caution .....	4

## Basic System Information

Index .....	5
Location of Controls & Indicators .....	6
Location of Jacks and Terminals .....	7
Remote Control .....	8
Important Safeguards and Precautions .....	9
Features of This System .....	10
Important Information Regarding This Manual .....	10
High Quality Digital Audio .....	10
Compatible with a wide range of DVD Digital Audio Output Formats .....	10
Locale Management Information .....	10
Types of Discs That Can be Played on This System .....	11
Notes on Disc Handling .....	12

## Installations and Connections

Unpacking .....	13
Inserting Batteries into the Remote Control .....	13
Protect Your Furniture .....	13
TV and Optical Component Connections .....	14
Connecting the AC power Cord .....	14

## DVD Playback

Basic Play .....	15
Skipping Chapters or Tracks .....	16
Slow-motion play by remote control only .....	16
Selecting Scenes by Chapter Number .....	16
Selecting a Start Point using the Title Time Code .....	17
Selecting a Start Point using the Chapter Time Code.....	17
Repeat Play .....	17
Repeat sections between two specific points (Repeat A-B) .....	18
Random Play .....	18
Changing the Audio Output Signal Audio CDs .....	18
CD-R/RW playback .....	19
Picture CD Operation .....	19

## Convenient Functions

Changing Audio Soundtrack Language .....	20
Viewing from another angle .....	20
Clearing & Displaying of Subtitles .....	20
Changing Subtitle Language .....	21
Selection of Titles .....	21
Using a DVD Menu .....	21
Audio CD Playback .....	22
Basic Play .....	22
When the unit is not in use .....	22

## Setting and Adjustments

TV Display .....	23
TV Type .....	23
Angle Mark .....	23
On Screen Display Language .....	24
Captions .....	24
Screen Saver .....	24
Downmix .....	25
Dynamic .....	25
Audio .....	25
Subtitle .....	26
Disc Menu .....	26
Parental .....	26
Password .....	27

## Other Functions

Zoom .....	27
Common Procedure .....	27
Key Lock .....	27

## Additional Information







Troubleshooting .....	28-29
Contact Customer Service .....	29
Warranty .....	30

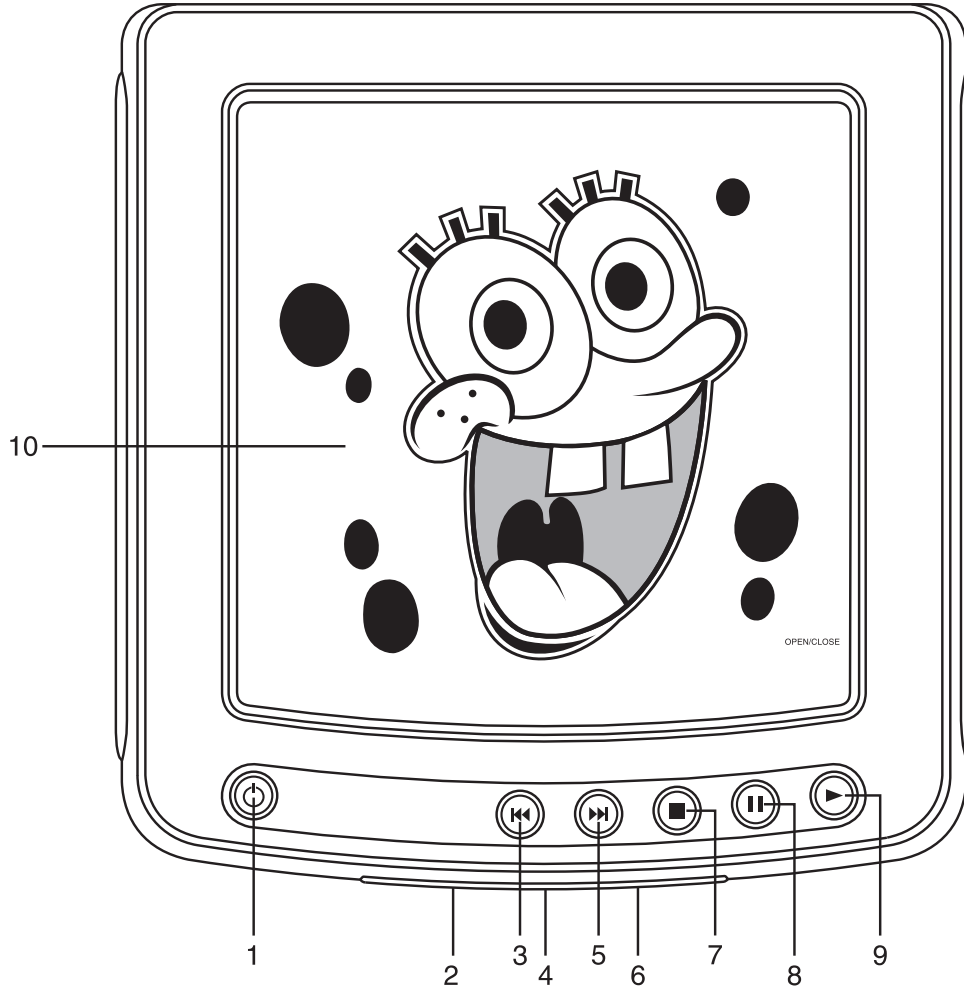

## LOCATION OF CONTROLS AND INDICATORS

### MAIN UNIT (Front View)



- 1.)  Standby Button.  
Turns the system 'On/Off'.
- 2.) **STANDBY** LED Indicator.  
Lights up to indicate standby mode.
- 3.)  Skip Reverse Button.  
Skip to previous chapter.
- 4.) **IR** Remote Sensor Indicator.  
Flashes when receiving signal from remote control.
- 5.)  Skip Forward Button.  
Skip to next chapter.
- 6.) Remote **SENSOR**.  
Receives the commands from the remote control.
- 7.)  Stop Button.  
Stop playing the disc.
- 8.)  Pause Button.  
Press to pause playback.
- 9.)  Play Button.  
Press to begin playback.
- 10.) Disc Compartment.



## LOCATION OF JACK AND TERMINALS

### MAIN UNIT (Back Panel)

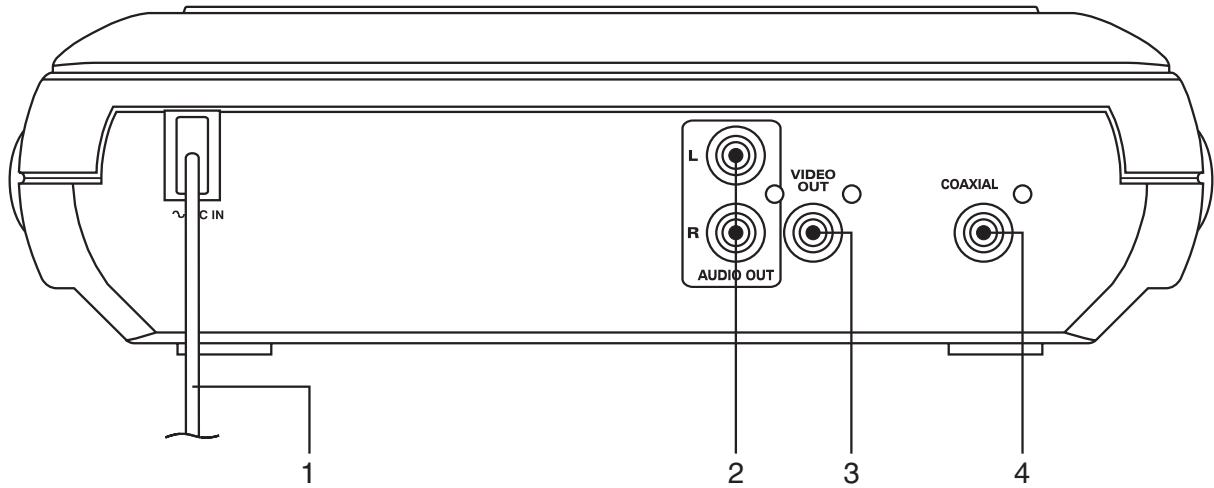

- 1.) AC Power Cord.
- 2.) **AUDIO OUT L/R** Jacks.
- 3.) **VIDEO OUT** Jack.
- 4.) **COAXIAL** Digital Out Jack.





## REMOTE CONTROL

- 1.) **KEY LOCK** Button.
- 2.) Numeric (**0-9**) Buttons.
- 3.) **TITLE MENU** Button.
- 4.) **SUBTITLE MENU** Button.
- 5.) **DISPLAY** Button.
- 6.) **ANGLE** Button.
- 7.) **SETUP** Button.
- 8.) **^ / v / < / >** Navigation Buttons.
- 9.) **RETURN** Button.
- 10.) **PBC** Button.
- 11.) **■ STOP** Button.
- 12.) **STEP** Button.
- 13.) **PAUSE** Button.
- 14.) **◀◀** Search Reverse Button.
- 15.) **RANDOM** Button.
- 16.) **MUTE** Button.
- 17.) **REPEAT** Button.
- 18.) **A-B** Repeat Button.
- 19.) **▶** Play Button.
- 20.) **SLOW/F** Button.
- 21.) **▶▶** Skip Forward Button.
- 22.) **◀◀** Skip Reverse Button.
- 23.) **CLEAR** Button.
- 24.) **SEARCH** Button.
- 25.) **ENTER** Button.
- 26.) **▶** Play Button.
- 27.) **AUDIO MODE** Button.
- 28.) **ZOOM** Button.
- 29.) **AUDIO MENU** Button.
- 30.) **DVD MENU** Button.
- 31.) **STANDBY ON/OFF** Button.

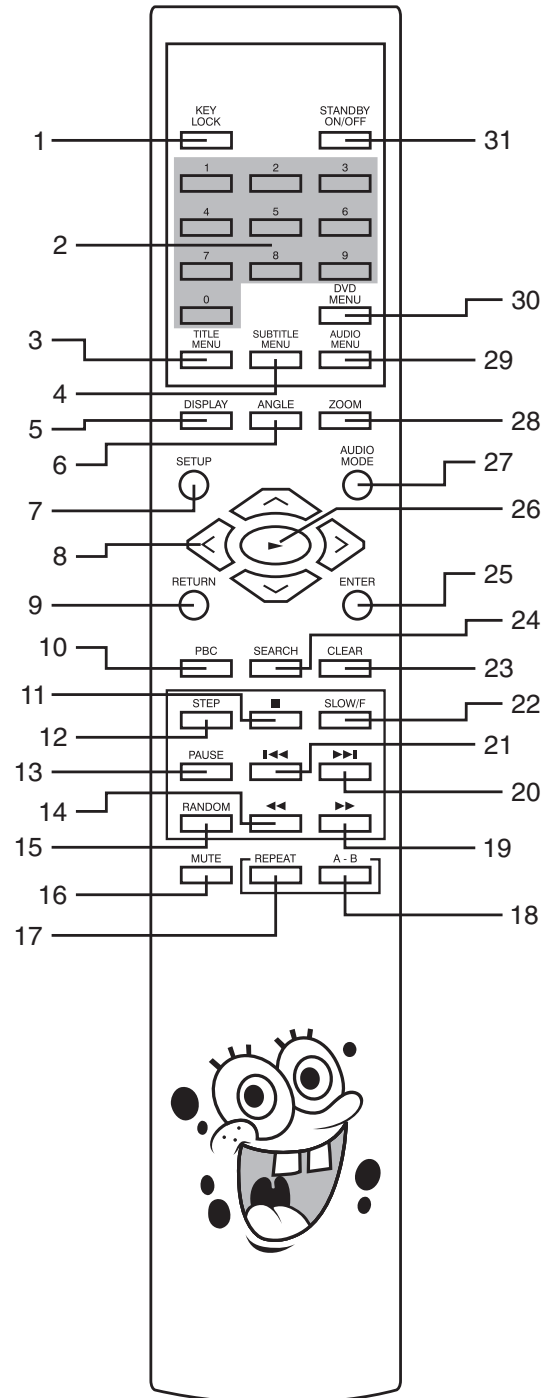



## Important Safeguards and Precautions

### Power Cord Protection

To avoid any malfunctions of the unit, and to protect against electric shock, fire or personal injury, please observe the following:

- Hold the plug firmly when connecting or disconnecting the AC power cord.
- Keep the AC power cord away from heating appliances.
- Never put any heavy object on the AC power cord.
- Do not attempt to repair or reconstruct the AC power cord in any way.

### Location and Handling

- Air vents are provided in the cabinet to prevent excessive temperatures inside the unit. Do not place this unit in closed spaces, cover it, or otherwise block the vents.
- Do not place this unit in direct sunlight, or near heat sources.
- Keep this unit away from strong magnetic objects.
- Do not insert or drop anything into this unit through the air vents as this could cause serious damage possibly resulting in fire.
- Do not place any object containing water or other liquids on this unit. In the event that liquid should enter the cabinet, unplug this unit immediately and contact the retailer or service center immediately.
- Do not remove the cabinet. Touching parts inside the cabinet could result in electric shock and / or damage to the unit.
- Do not use the unit in a car. The operation can not guaranteed.

### Non-Use Periods

- When the unit is not being used, turn the unit off.
- When left unused for a long period of time, the unit should be unplugged from the household AC outlet.

### No Fingers or Other Objects Inside

Do not put any foreign object on the disc tray.

### Stacking

Place the unit in a horizontal position, and do not place anything heavy on it.

### Condensation

Moisture may form on the pickup lens in the following conditions:

- Immediately after a heater has been turned on.
- In a steamy or very humid room.
- When the unit is suddenly moved from a cold environment to a warm one.

If moisture forms inside this unit, it may not operate properly. In this case, turn on the power and wait about one hour for the moisture to evaporate.

### On Adjusting Volume

Do not turn up the volume while listening to a portion with very low level inputs or no audio signals. If you do, the speakers may be damaged when a peak level portion is played.

### If There is Noise Interference on the TV While a Broadcast is Being Received

Depending on the reception condition of the TV, interference may appear on the TV monitor while you watch a TV broadcast and the unit is left on. This is not a malfunction of the unit or the TV. To watch a TV broadcast, turn off the unit.

### Service

- Do not attempt to service the unit yourself.
- Please call 1-800-898-9020 for the name of the nearest service center.

### Copyright

Audio-visual material may consist of copyrighted works which must not be recorded without the authority of the owner of the copyright. Please refer to relevant laws covering copyright protection.

### Copy protection

This DVD player supports Macrovision copy protection. On DVD discs that include a copy protection code, if the contents of the DVD disc are copied using a VCR, the copy protection code prevents the videotape copy from playing normally.

### Recommended measures for Optimum Performance

This unit is a precision device that is constructed using extremely accurate technology. Soiling or friction affecting the pickup lens or disc drive can impair the image quality. In the worst case, neither video nor audio will be played back. To obtain optimum picture quality, the player should be checked (cleaning and replacement of some parts) every 1,000 hours. Note that this period varies depending on the environment (temperature, humidity, dust, etc..) in which the player is used.

### Do not attempt to clean the pickup lens yourself.

### Notes:

- Periodically inspect for damage, if damaged properly repair the DVD player before use.
- Adult supervision recommended.



---

## Features of This System

- DVD player with Dolby Digital\* Audio output.
- Compatible with DVD, CD-R/RW, KODAK PHOTO CDs and CD discs.
- DVD navigation functions.
- On screen display menu.
- Full function remote control.

\* Manufactured under license from Dolby Laboratories. "Dolby", "AC-3", "Pro Logic" and the double-D symbol are trademarks of Dolby Laboratories. Confidential Unpublished Works. ©1992-1997 Dolby Laboratories, Inc. All rights reserved.

---

## Important Information Regarding This Manual

- The types of functions and operations that can be used for a particular disc vary depending on the features of that disc. In some cases, these functions and operations may differ from the descriptions given in this Operations Manual. In this event, follow the instructions given on the screen. This Operations Manual only covers basic disc operations.
- For some operations, the "INVALID KEY" statement may appear on the screen. This indicates that the operation described in this Operations Manual is not available on the disc in the player.
- The drawings about the TV screen used in this Operations Manual are purely for the purposes of explanation. The actual displays may differ slightly from what are shown here.

---

## High Quality Digital Audio

- With the linear PCM sound of 48 kHz /16 bit through 96 kHz / 20 bit, audio quality exceeding that of audio CDs is possible.

---

## Compatible with a wide range of DVD Digital Audio Output Formats

DVDs are recorded in one of four types of digital audio formats (as of October 1998). The digital audio output jack of this player can output Dolby Digital\*, MPEG, and linear PCM digital bitstreams.

---



## Locale Management Information:

This DVD player is designed and manufactured to respond to the Locale Management Information that is recorded on a DVD disc. If the Locale number described on the DVD disc does not correspond to the Locale number of this DVD player, this DVD player cannot play that disc.



## TYPES of DISCS That Can be Played on This System

This player can playback discs bearing any of the following marks:

 	
<p>DVDs 12 cm disc / 8 cm disc</p>	<p>Audio CDs 12 cm disc / 8 cm disc • Support CD, CD-R/RW KODAK PHOTO CD</p>

### Note-1

- DVD players and discs are designed with region numbers which dictate the regions in which a disc can be played. If the region number on the disc you want to play does not match the region number in your DVD player, you will not be able to play the disc. If you try to play the DVD, the message "WRONG REGION" will appear on the screen display.

The region number for this DVD player is  .  
The region code of this player is printed on the rear of the unit.

Sample disc display:



### Note-2

- The specific playback functionality for some DVD and video CD discs is determined by the disc manufacturer. Because this DVD player plays disc data in accordance with the disc manufacturer's guidelines, some functions may not be available on some discs. Be sure to read the instructions provided with the disc.

**The "Prohibited" statement displayed during DVD player operation indicates that such manufacturer imposed restrictions apply.**

### Note-3

- The audio on a DVD disc recorded in MPEG version 2.0 format may not play properly on some discs, only the image will appear in this case.

### Discs that Cannot be Played

- You cannot play CD-G, CD-EXTRA, CD-ROM and DVD-ROM discs.
- You cannot play illegally produced discs.
- You cannot play scratched discs.
- You cannot play discs that are dusty, soiled or marked with fingerprints.

### Icons used on DVD discs

Sample Icons:

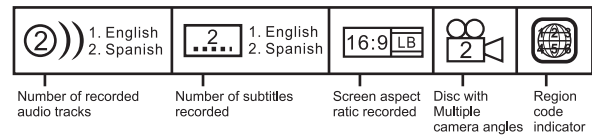

### Glossary of Disc Terms

- Title (DVD)**  
The longest sections of picture or a music piece on a DVD, a movie, etc., for a picture piece on a video disc; or an album, etc., for a music piece on an audio disc. Each title is assigned a title number enabling you to locate the title you want.
- Chapter (DVD)**  
Sections of a picture or a music piece that are smaller than titles. A title is composed of several chapters. Each chapter is assigned a chapter number enabling you to locate the chapter you want. Some discs may not contain chapters.
- Track (Audio CD)**  
Sections of a music piece on an audio CD. Each track is assigned a track number enabling you to locate the track you want.

For example

Title 1	Chapter 1
	Chapter 2
Title 2	Chapter 1
	Chapter 2
	Chapter 3



## Notes on Discs

### Disc handling precautions

- To keep the disc clean, handle the disc by its edge. Do not touch the surface.
- Do not stick paper or tape on the disc.  
If there is glue (or a similar substance) on the disc, remove the glue completely before using the disc.

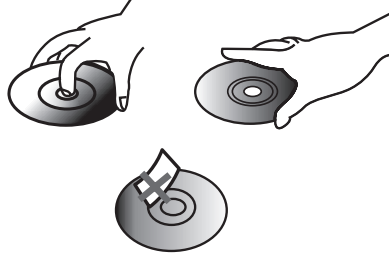

- Do not expose the disc to direct sunlight or sources such as hot air ducts, or leave it in a car parked indirect sunlight as there can be considerable rise in temperature inside the car.
- After playing, store the disc in its case.
- Do not write on the label side with a ball-point pen or other writing utensils.
- Be careful not to drop or bend the disc.

### Disc cleaning precautions

- Before playing, clean the disc with a cleaning cloth. Wipe the disc from the center out.

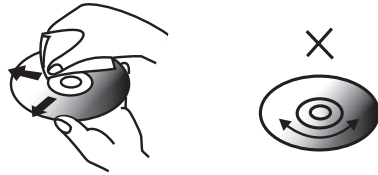

- Do not use solvents such as benzine, thinner, commercially available cleaners or anti-static spray intended for vinyl LPs.

### Disc installing precautions

- Do not install more than 1 disc on disc tray.
- Do not place the disc on the tray up-side down.
- Do not try to close the disc tray when the disc is not installed and centered properly.

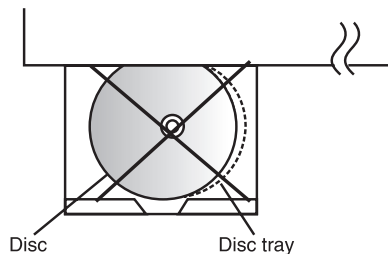



## Installation

This section describes how to connect the system to a TV monitor with audio/video input jacks. You cannot connect this system to a TV monitor which does not have a video input connector. Be sure to turn off the power of each component before making the connections.

## Unpacking

Check that you have the following items:

- Main unit (1).
- Remote control (1).
- Audio/Video cable (4 feet x 1).
- Owner's Manual (1).

## Inserting Batteries into the Remote Control

You can control the system using the supplied remote. Insert two "AA" batteries by matching the + and - on the batteries with the markings in the battery compartment. When using the remote, point it at the remote sensor on the front panel of this system.

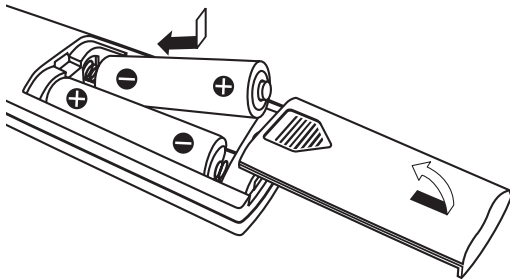

### Notes:

- Do not leave the remote in an extremely hot or humid place.
- Do not use a new battery with an old one.
- Do not drop any foreign object into the remote casing, particularly when replacing the batteries.
- Do not expose the remote sensor to direct sunlight or lighting apparatuses. Doing so may cause a malfunction.
- If you do not use the remote for an extended period of time, remove the batteries to avoid possible damage from battery leakage and corrosion.
- Use only the size and type of batteries specified.
- Be sure to follow the correct polarity when installing the batteries as indicated in the battery compartment. Reversed batteries may cause damage to the device.
- Do not mix different types of batteries together (e.g. Alkaline and Carbon-zinc) or old batteries with fresh ones.



## TV and Optional Component Connections

### Required cords

- Video cord for connecting a TV set (included).

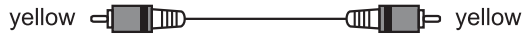

- Audio cords (included).  
When connecting a cord, be sure to match the color-coded pins to the appropriate jacks on the components.

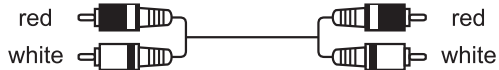

### Notes:

- **TV Connection-Normal (Connection Cable Included):**  
To view the video from DVD discs on your TV set connect the Video Out jack of this system to the Video In jack of your TV set. The Video jacks are usually colored yellow.

- **TV Connection-Audio (Connection Cables Included):**  
Connect the Left/Right audio output jacks of your system to the Left/Right audio input jacks of the TV set.

- **External Decoder Connection-Not Required:**  
The Coaxial Digital Audio output jack allows digital audio signals to be fed to an external Dolby Digital decoder if desired. The Coaxial digital audio connection cable is not included.

## Connecting the AC Power Cord

### Notes:

- The Power Requirement is: AC 120V, 60Hz.
- Connecting to power other than the one listed above may damage the system or cause abnormal operation.
- Before connecting the AC power cord of this system to a wall outlet, connect the speakers and other component cables to the system.
- Connect the AC power cords of your TV and any optional connect to a wall outlet.

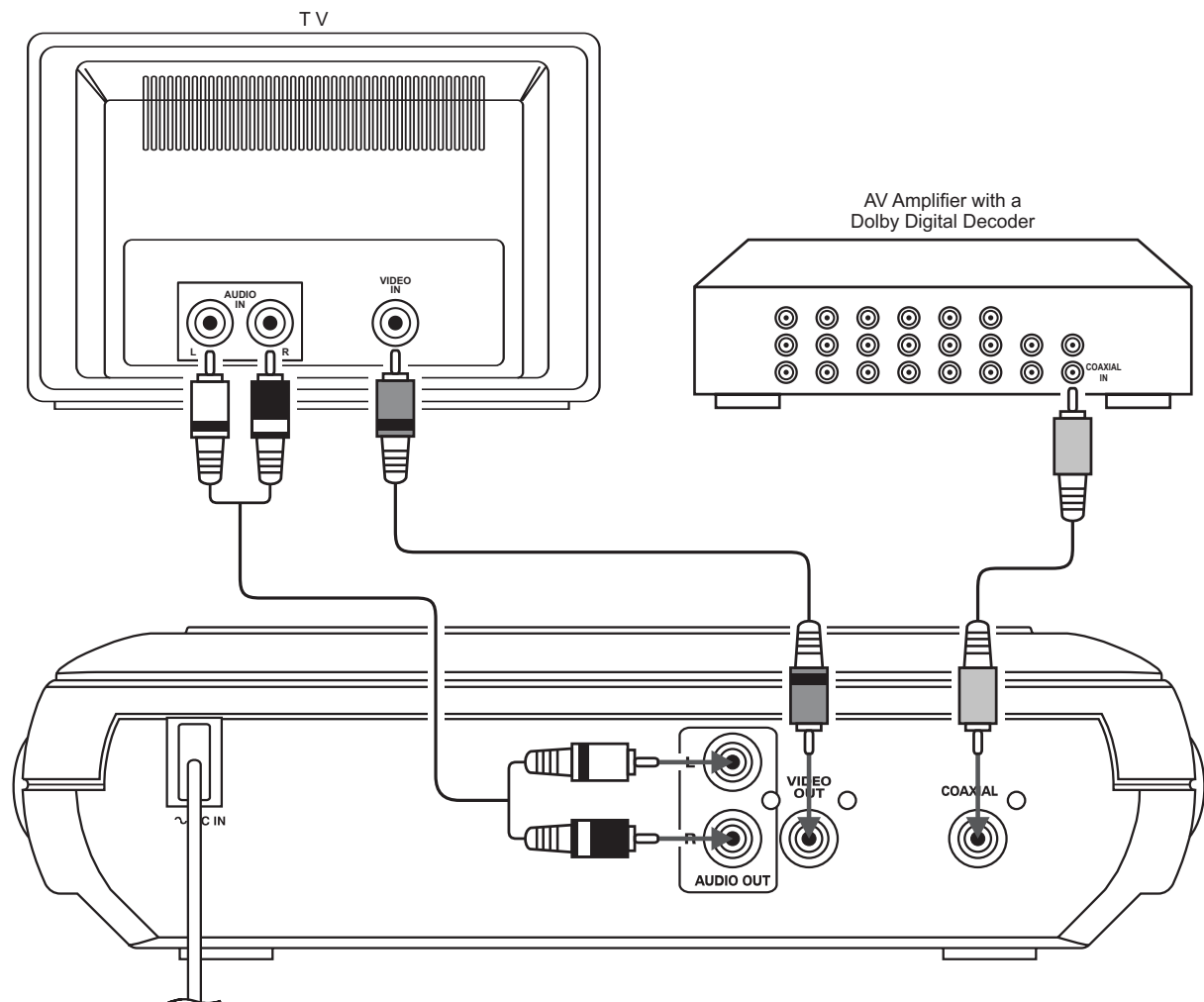



## DVD Playback

### Preparations

- Switch on the TV set power and select "Video" as the TV input.
- Switch on the stereo system's power if the player has been connected to a stereo system.

### Basic Play

1. Press down on the disc compartment lid (OPEN/CLOSE) to open the disc compartment.
2. Place a disc into the disc compartment.  
Hold the disc without touching either of its surfaces and with the printed title side facing up. Align it with the guides and place it in its proper position.
3. Close the disc compartment.
4. Press the PLAY ► button if the movie has not started automatically.

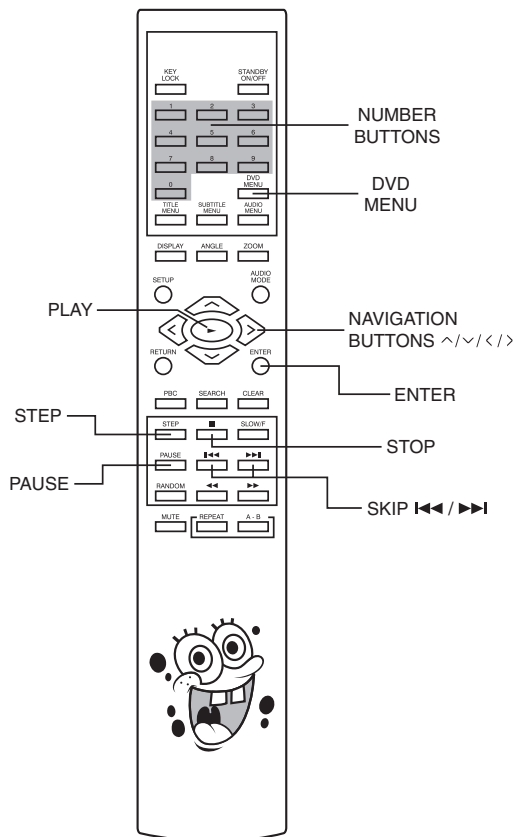
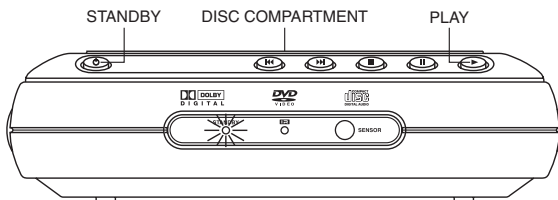

- If the disc has one or more titles recorded on it, a menu screen will appear on the TV screen after a few moments.
5. Select the preferred title by using the ( < , > , ^ , v ) Navigation buttons, followed by the ENTER button, or press the number button corresponding to the menu.
  - Play of the selected title now commences.

### When the menu continues onto another screen

After step 3 on previous page, press SKIP ►►.

- To return to the previous menu screen, press SKIP ◀◀.
- For further details, refer also to the disc jacket.

### Stopping play and returning to the menu screen

Press the DVD MENU button.

- Play is suspended and the menu screen is displayed.

### When the unit is not in use

When the unit is not in use, remove the disc and press the STANDBY button to turn off the power. The STANDBY indicator will illuminate.

### Notes:

- The disc continues to rotate while the menu is displayed even after the player has finished playing a particular item. When no further selections are to be played, be sure to press the STOP ■ button to clear the menu display.
- If the disc is placed in upside down, the On Screen Display will indicate "NO DISC".

### For your reference

- When "⊘" appears on the TV screen while a button is being operated, it means that the corresponding operation is prohibited by the player.

### Stopping play

- Press the STOP ■ button.

### For your convenience

- When play is stopped, the unit records the point when STOP ■ was pressed (RESUME function). Press PLAY ► again and play will resume from this point. When the tray is opened or STOP ■ is pressed again, the RESUME function will be cleared. The RESUME function works only with discs for which the elapsed playing time appears during playback.

### Still picture

Press the PAUSE button during play.

### To return to normal play

Press PLAY ►.

### Frame advance

- Press the PAUSE button to advance to still picture mode.
- Press STEP until the desired frame is displayed. The disc is advanced one frame each time the STEP button is pressed.





## Skipping Chapters or Tracks

### Skipping ahead

Press SKIP ► during play.

- A chapter is skipped each time the button is pressed.

### Skipping back

Press SKIP ◀ during play.

## Slow-motion Play by Remote Control Only

Press the SLOW/F button during play. Each time you press the button, the speed changes from: 1/2, 1/4, 1/8, 1/16.

### To return to normal play

- Press PLAY ► button.

### Search: rapid advance-rapid reverse

Press the SEARCH ◀ or ► button(s). Each time you press the button, the speed change from: x2, x4, x8, x16.

BACKWARD x2 ◀◀ = Fast Reverse 1

BACKWARD x4 ◀◀ = Fast Reverse 2

BACKWARD x8 ◀◀ = Fast Reverse 3

BACKWARD x16 ◀◀ = Fast Reverse 4

FORWARD x2 ►► = Fast Forward 1

FORWARD x4 ►► = Fast Forward 2

FORWARD x8 ►► = Fast Forward 3

FORWARD x16 ►► = Fast Forward 4

### To return to normal play

- Press the PLAY ► button.

## Selecting Scenes by Chapter Number

**Example:** Starting play from Chapter 03.

1. Press the SEARCH button during play.



2. Press the Number button(s) to select the preferred chapter.

**Example:** Press '0', '3'.



3. Play now commences from Chapter 03.

**Note:** Depending on the disc used, it may not be possible to perform these operations during DVD menu play.

### For your reference

"⊘ INPUT INVALID" appears on the TV monitor if the number selected does not exist on the disc.

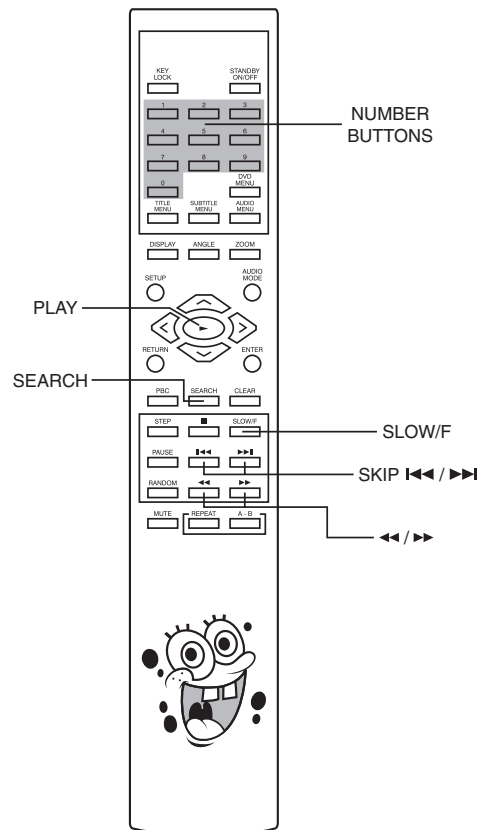



## Selecting a Start Point using the Title Time Code

**Example:** Viewing after 1 hour 3 minutes have elapsed from the title start.

1. Press the SEARCH button twice during play.

TT 01/03 T : :

2. Press the Number button(s) to specify the starting position.

**Example:** To specify "1 hour 3 min.00sec.", press '1', '0', '0', '3', '0', and '0'.

TT 01/03 T 1:03:00

3. Play now commences from the specified position.

### Notes:

- This operation works only with discs for which the elapsed playing time appears during playback.
- For some discs, play may not start from the specified position even when the steps above have been performed correctly.
- Depending on the disc used, it may not be possible to perform these operations during DVD menu play.

## Selecting a Start Point using the Chapter Time Code

**Example:** Viewing after 1 hour 3 minutes have elapsed from the chapter start.

1. Press the SEARCH button thirdly during play.

CH 01/06 T : :

2. Press the Number button(s) to select the preferred chapter.

**Example:** To specify 1 hour 3 min 00 sec, press '1', '0', '3', '0', '0'.

CH 01/06 T 1:03:00

3. Play now commences from Title 2.

**Note:** Depending on the disc used, it may not be possible to perform these operations during DVD menu play.

### For your reference

"⊘ INPUT INVALID" appears on the TV screen if the number selected does not exist on the disc.

## Repeat Play

1. Press the REPEAT button once and "↻ Track" will appear on the TV screen and the unit will repeat the selected track / file continuously until the STOP ■ button is pressed.
2. Press the REPEAT button twice and "↻ ALL" will appear on the TV screen and the unit will repeat the whole CD continuously until the STOP ■ button is pressed.
3. Press the REPEAT button again to resume normal playback.

### Repeat viewing

1. Press the REPEAT button during play as follow:

↻Chapter

REPEAT x1 = Repeat Chapter

↻Title

REPEAT x2 = Repeat Title

↻Off

REPEAT x3 = Repeat Off

**Note:** Repeat play may not work correctly with some DVDs.

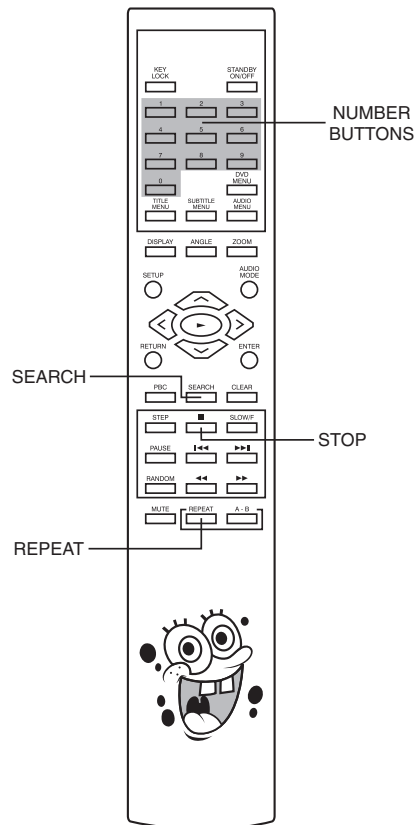



## Repeat sections between two specific points (Repeat A - B)

1. Press the REPEAT A - B button during play at the point where repeat play is to commence (A).



2. Press the REPEAT A - B button again at the point where repeat play is to be concluded (B).



Repeat play of the selection between points A and B starts automatically. The section from point A to point B will play repeatedly.

### To return to normal play

- Press the REPEAT A - B button again.

**Note:** Some subtitles recorded around point A or B may fail to appear.

## Changing the Audio Output Signal Audio CD's

1. Press the AUDIO MODE button repeatedly to choose between MONO LEFT, MONO RIGHT, MIX MONO, and STEREO.

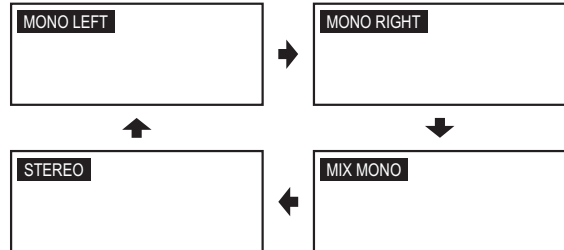

- MONO LEFT and MONO RIGHT modes will combine the original stereo signal into one mono signal (use this mode when playing on a mono TV).
- MIX MONO mode allows you to mix the left or right channel into 1 mono signal.
- These functions work only for discs recorded with these features.

## Random Play

1. Press the RANDOM button after loading the disc.



2. Press the STOP button to turn Random Play OFF.



- To cancel Random mode, press RANDOM button.

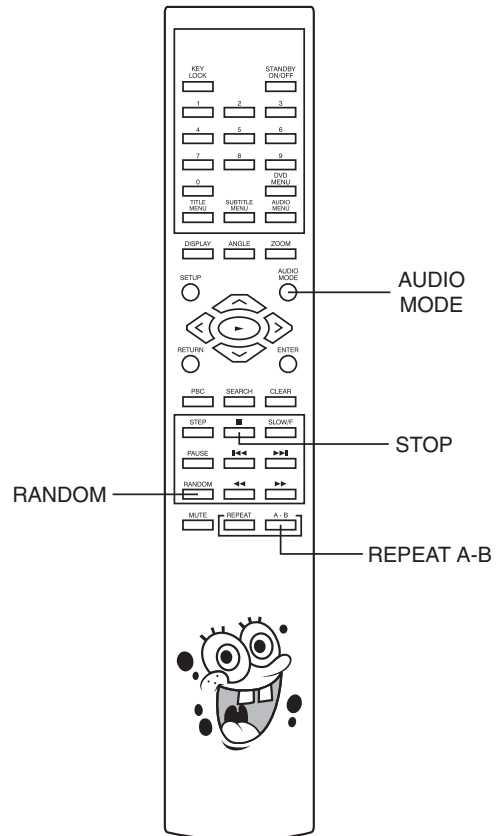



## CD-R/RW Playback

### Important Information

The DVD player in this system can play normal audio CDs, recordable CDs (CD-Rs), re-writable CD's (CD-RWs). However, because of the non-compatibility of certain ripping/burning software used to record CDs, and the quality of the blank discs used for recording, 100% playability of CD-RW cannot be guaranteed. This is not an indication of any problem with your system.

- When a normal audio CD, a CD-R, or a CD-RW disc is loaded in the player the "CD" indicator will light.

## Picture CD Operation

1. After loading a picture CD disc into the disc tray, the picture CD menu will appear on the TV screen.

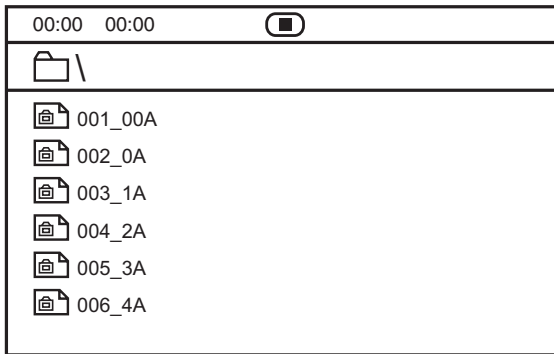

2. Press the ( ^ , v ) Navigation buttons to select your desired folder.
3. Press the ENTER button to confirm your selection and start the playback of picture CD disc.

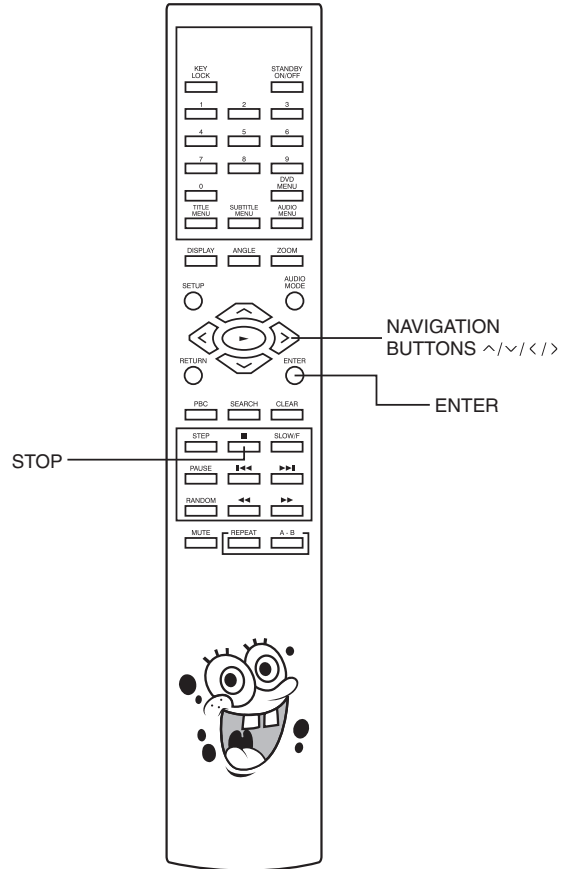



## Convenient Functions

### Changing Audio Soundtrack Language

It is possible to change the audio soundtrack language from English to a different language, if available. (This operation works only with discs on which multiple audio soundtrack languages are recorded.)

1. Press the AUDIO MENU button during play.
2. Press the AUDIO MENU button repeatedly to select the preferred language.

#### For your reference

- The choice of languages is limited to those that are available on the disc being played. All discs do not have all languages available.
- When the power is turned on or the disc is removed, the language heard is the one selected initially. If this language is not recorded on the disc, only the language available on the disc will be heard.
- The unit is factory preset to ENGLISH.

### Viewing from another angle

Some DVD discs may contain scenes which have been shot simultaneously from a number of different angles. For these discs, the same scene can be viewed from each of these different angles using the ANGLE button. (The recorded angles differ depending on the disc used.)

1. Press the ANGLE button during play.
2. Press the ANGLE button to select the preferred angle.

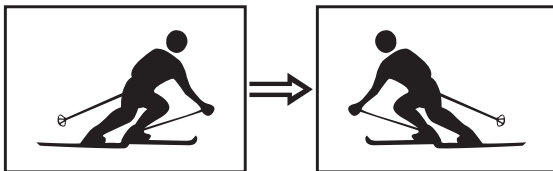

**Note:** This function will only work on discs where different angles have been recorded.

### Clearing & Displaying of Subtitles

If a disc has subtitles recorded on it, they can either be displayed or cleared on the TV screen. (This operation works only with discs on which the subtitle language is recorded.)

- Press the SUBTITLE MENU button during play.

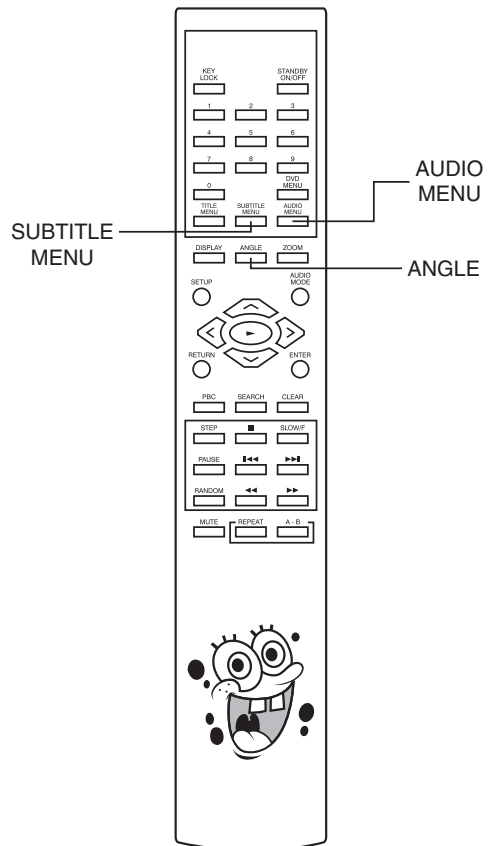



## Changing Subtitle Language

It is possible to change the subtitle language from English to a different language, if available. (This operation works only with discs on which multiple subtitle languages are recorded.)

1. Press the SUBTITLE MENU button during play.
2. Press the SUBTITLE MENU button repeatedly to select the preferred language.

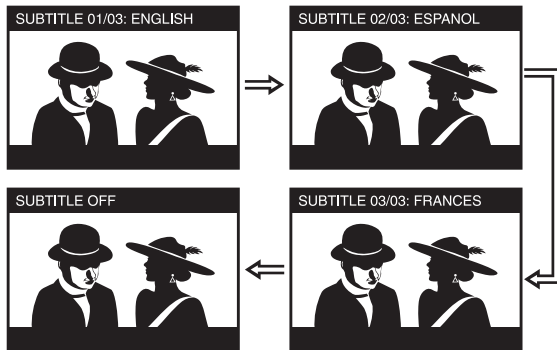

### Notes:

- In some cases, the subtitle language is not changed immediately to the selected one.
- When the power is turned off or the disc is removed, subtitles appear in the language selected at the initial settings. If this language is not recorded on the disc, they will appear in the disc's priority language.

## Selection of Titles

Some DVDs may have more than 1 movie (Title) on them. If the disc has a title menu recorded on it, the TITLE MENU button can be used to select the desired title. (The details of operation differ depending on the disc used.)

1. Press the TITLE MENU button during play. A list of titles on the disc is now displayed.
2. Press the ( < , > , ^ , v ) Navigation buttons to select the preferred title.
3. Press the ENTER button. The selected title now starts playing.

## Using a DVD Menu

Some DVD discs have unique menu structures called DVD menus. For example, DVDs programmed with complex contents provide guide menus and those recorded with various languages provide menus for audio and subtitle language. Although the DVD menu's contents and operation differ from disc to disc, the following explains the basic operation when this feature is used.

1. Press the DVD MENU button during play. The DVD menu available on the disc is now displayed.
2. Press the ( < , > , ^ , v ) Navigation buttons to select the preferred menu.
3. Press the ENTER button. The selected item is now executed.

### When the menu continues onto another screen

Repeat step 2 and 3.

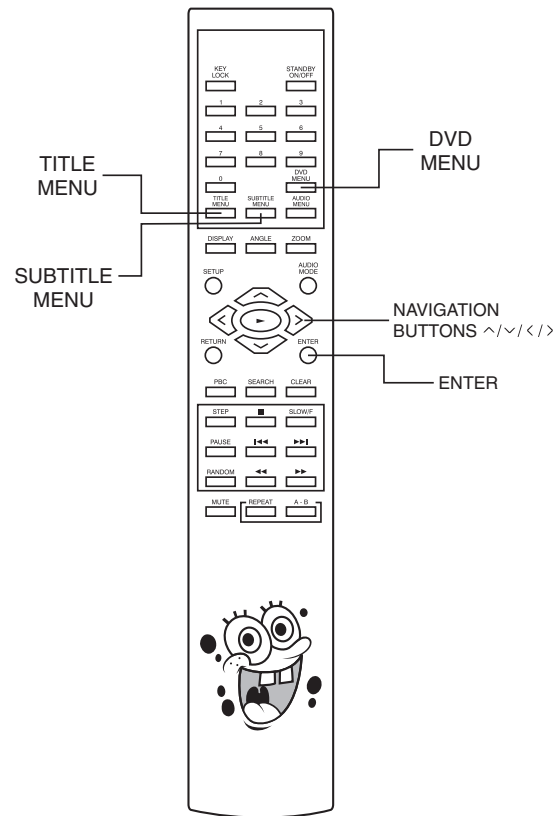



## Audio CD Playback

### Preparation

- Switch on the TV set power and select "Video" as the TV input.
- Switch on the stereo system's power if the player has been connected to a stereo system.

## Basic Play

1. Press down on the disc compartment lid (OPEN/CLOSE) to open the disc compartment.
2. Place a disc into the disc compartment.  
Hold the disc without touching either of its surfaces and position it with the printed title side facing up. Align it with the guides and place it in its proper position.
3. Press the PLAY ► button.

**Note:** Make sure the TV type is set to NTSC (factory default).

## When the unit is not in use

When the unit is not in use, remove the disc and press the STANDBY button to turn off the power. The STANDBY indicator will illuminate.

### Notes:

- The disc continues to rotate while the menu is displayed even after the player has finished playing a particular item. When no further selections are to be played, be sure to press the STOP ■ button to clear the menu display.
- If the disc is placed in upside down, the On Screen Display will indicate "NO DISC".

### For your reference

- When "⊘" appears while a button is being operated, it means that the corresponding operation is prohibited by the player.

### For your convenience

When play is stopped, the unit records the point where STOP ■ was pressed. Press PLAY ► again, and play will resume from this point. When the tray is opened, the RESUME function will be cleared. The RESUME function works only with discs for which the elapsed playing time appears during playback.

### Still Picture (PAUSE/STILL)

- Press the PAUSE button during play.

### Audio CD

- The player will be placed in the pause mode.

### To return to normal play

- Press PLAY ► button.

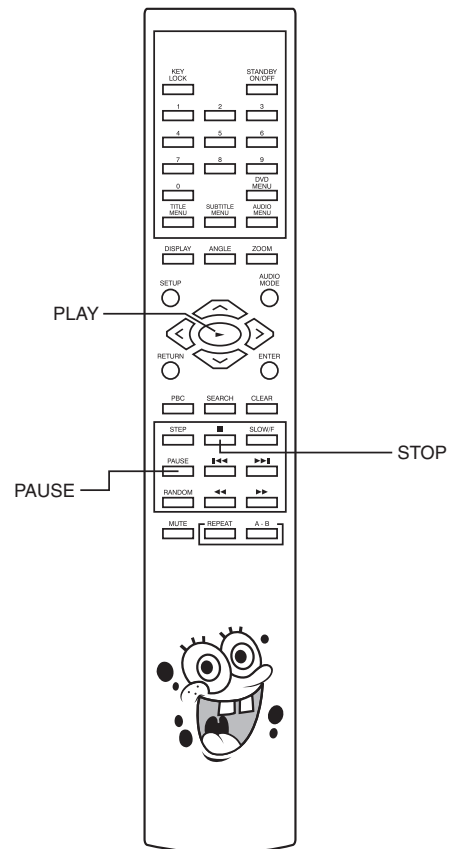
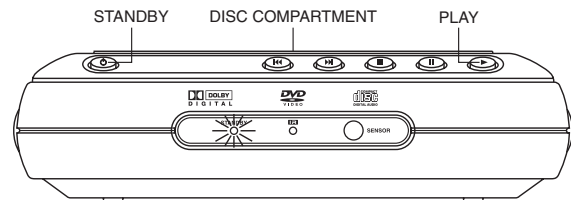



## Settings and Adjustments

Once the initial setup has been completed, the player can always be operated under the same conditions. The settings will be retained in the memory, until the settings are changed.

### TV Display

1. Press the SETUP button to enter the Setup Menu.
2. Use the ( < , > ) Navigation buttons to select General.
3. Use the ( ^ , v ) Navigation buttons to move the cursor to the TV Display item.
4. Use the ( > ) Navigation button followed by the ( ^ , v ) Navigation buttons to select between Normal/PS (Pan & Scan), Normal/LB (Letterbox), and Wide formats.

#### Normal/PS (Pan & Scan):

Video material formatted in the PAN & SCAN style is played in that style (the left and right edges are cut off).

#### Normal/LB (Letterbox):

Video material not formatted in the Letterbox style is played in the Pan & Scan style.

#### Wide:

Select this for a wide screen TV set.

5. Press the ENTER button.
6. Using the ( < , > , ^ , v ) Navigation buttons and press ENTER to exit and save setting.

General	Audio	Dolby	Preference
-- General Setup Page --			
TV Display	PS	Normal/PS	
TV Type	NTSC	Normal/LB	
Angle Mark	ON	Wide	
OSD Lang	ENG		
Captions	ON		
Screen Saver	ON		
Set TV Display Mode			

### TV Type

1. Press the SETUP button to enter the Setup Menu.
2. Use the ( < , > ) Navigation buttons to select General.
3. Use the ( ^ , v ) Navigation buttons to move the cursor to the TV Type item.

4. Use the ( > ) Navigation button followed by the ( ^ , v ) Navigation buttons to select between NTSC, and PAL modes.
5. Press the ENTER button.
6. Using the ( < , > , ^ , v ) Navigation buttons and press ENTER to exit and save setting.

General	Audio	Dolby	Preference
-- General Setup Page --			
TV Display	PS		
TV Type	NTSC	NTSC	
Angle Mark	ON	PAL	
OSD Lang	ENG		
Captions	ON		
Screen Saver	ON		
Set TV Standard			

### Angle Mark

1. Press the SETUP button to enter the Setup Menu.
2. Use the ( < , > ) Navigation buttons to select General.
3. Use the ( ^ , v ) Navigation buttons to move the cursor to the Angle Mark item.
4. Use the ( > ) Navigation button followed by the ( ^ , v ) Navigation buttons to select between On and Off modes. This only works when there is an angle mark on the disc.

**Note:** Select "On" the screen shows the angle mark when playing a DVD.  
Select "Off" the angle mark is not shown.

5. Press the ENTER button.
6. Using the ( < , > , ^ , v ) Navigation buttons and press ENTER to exit and save setting.

General	Audio	Dolby	Preference
-- General Setup Page --			
TV Display	PS		
TV Type	NTSC		
Angle Mark	ON	On	
OSD Lang	ENG	Off	
Captions	ON		
Screen Saver	ON		
Set Angle Mark			





## On Screen Display Language

1. Press the SETUP button to enter the Setup Menu.
2. Use the ( < , > ) Navigation buttons to select General.
3. Use the ( ^ , v ) Navigation buttons to move the cursor to the OSD Lang item.
4. Use the ( > ) Navigation button followed by the ( ^ , v ) Navigation buttons to select between English, German, Spanish and French on screen display languages.
5. Press the ENTER button.
6. Using the ( < , > , ^ , v ) Navigation buttons and press ENTER to exit and save setting.

General	Audio	Dolby	Preference
-- General Setup Page --			
TV Display	PS		
TV Type	NTSC		
Angle Mark	ON		
OSD Lang	ENG	English	
Captions	ON	Spanish	
Screen Saver	ON	German	
		French	
Set OSD Language			

## Captions

1. Press the SETUP button to enter the Setup Menu.
  2. Use the ( < , > ) Navigation buttons to select General.
  3. Use the ( ^ , v ) Navigation buttons to move the cursor to the Captions item.
  4. Use the ( > ) Navigation button followed by the ( ^ , v ) Navigation buttons to select between On and Off modes.
    - Select this option when some newer DVD movies include closed captioning for hearing impaired viewers.
- Note:** Select "On" to switch on the captioning feature that describes other sounds being heard together with the dialog.  
Select "Off" the closed captions will not appear.
5. Press the ENTER button.
  6. Using the ( < , > , ^ , v ) Navigation buttons and press ENTER to exit and save setting.

General	Audio	Dolby	Preference
-- General Setup Page --			
TV Display	PS		
TV Type	NTSC		
Angle Mark	ON		
OSD Lang	ENG		
Captions	ON	On	
Screen Saver	ON	Off	
Closed Caption			

## Screen Saver

1. Press the SETUP button to enter the Setup Menu.
  2. Use the ( < , > ) Navigation buttons to select General.
  3. Use the ( ^ , v ) Navigation buttons to move the cursor to the Screen Saver item.
  4. Use the ( > ) Navigation button followed by the ( ^ , v ) Navigation buttons to select between ON and OFF modes.
- Note:** If you turn the screen saver on, the screen saver image appears when you leave the system in pause or stop mode for more than 1 minute. The screen saver is useful to prevent your display from becoming damaged.
5. Press the ENTER button.
  6. Using the ( < , > , ^ , v ) Navigation buttons and press ENTER to exit and save setting.

General	Audio	Dolby	Preference
-- General Setup Page --			
TV Display	PS		
TV Type	NTSC		
Angle Mark	ON		
OSD Lang	ENG		
Captions	ON		
Screen Saver	ON	On	
		Off	
Screen Saver			



## Downmix

1. Press the SETUP button to enter the Setup Menu.
2. Use the ( < , > ) Navigation buttons to select Audio.
3. Use the ( ^ , v ) Navigation buttons to move the cursor to the Downmix item.
4. Use the ( > ) Navigation button followed by the ( ^ , v ) Navigation buttons to select between LT/RT, Stereo modes.

**LT/RT:** The front speakers are in theatrical LT/RT downmix mode.

**Stereo:** The front speakers are in Stereo Downmix mode.

5. Press the ENTER button.
6. Using the ( < , > , ^ , v ) Navigation buttons and press ENTER to exit and save setting.

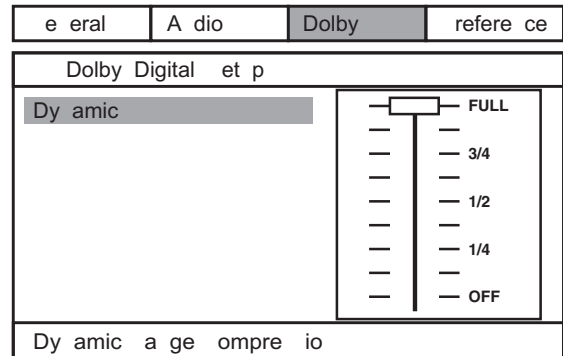
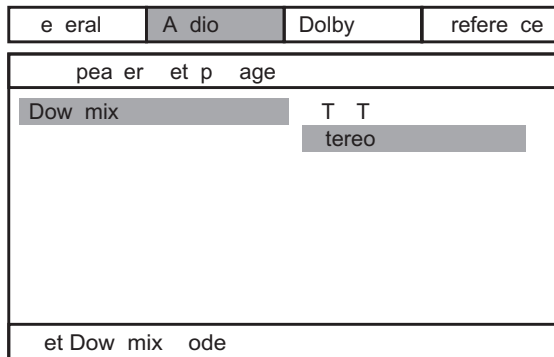

## Audio

1. Press the SETUP button to enter the Setup Menu.
2. Use the ( < , > ) Navigation buttons to select Preference.
3. Use the ( ^ , v ) Navigation buttons to move the cursor to the Audio item.
4. Use the ( > ) Navigation button followed by the ( ^ , v ) Navigation buttons to select between English, French, Spanish, German, and Japanese audio soundtrack languages\*.
5. Press the ENTER button.
6. Using the ( < , > , ^ , v ) Navigation buttons and press ENTER to exit and save setting.

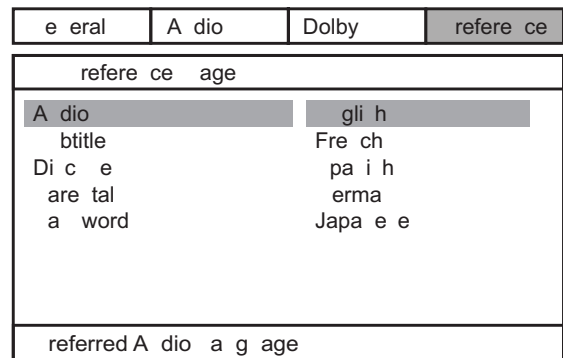

\* Actual available audio languages depend on the disc used.

## Dynamic

1. Press the SETUP button to enter the Setup Menu.
2. Use the ( < , > ) Navigation buttons to select Dolby.
3. Use the ( ^ , v ) Navigation buttons to move the cursor to the Dynamic item.
4. Use the ( > ) Navigation button followed by the ( ^ , v ) Navigation buttons to select between Full and off levels and 3/4 to 1/4 in between..

**Note:** Select your desired Dynamic Range Compression Rate (DRC) to adjust linear compression rate to obtain the different compression results of the signals.

5. Press the ENTER button.
6. Using the ( < , > , ^ , v ) Navigation buttons and press ENTER to exit and save setting.



## Subtitle

1. Press the SETUP button to enter the Setup Menu.
2. Use the ( < , > ) Navigation buttons to select Preference.
3. Use the ( ^ , v ) Navigation buttons to move the cursor to the Subtitle item.
4. Use the ( > ) Navigation button followed by the ( ^ , v ) Navigation buttons to select between English, French, Spanish, German, or Japanese subtitles\*. or turn subtitles Off.
5. Press the ENTER button.
6. Using the ( < , > , ^ , v ) Navigation buttons and press ENTER to exit and save setting.

e eral	A dio	Dolby	refere ce
refere ce age			
A dio		gli h	
btitle			
Di c e	Fre ch		
are tal	pa i h		
a word	erma		
	Japa e e		
	ff		
referred btitle a g age			

\* Actual available subtitle languages depend on the disc used.

e eral	A dio	Dolby	refere ce
refere ce age			
A dio		gli h	
btitle			
Di c e	Fre ch		
are tal	pa i h		
a word	erma		
	Japa e e		
referred e a g age			

\* Actual available menu languages depend on the disc used.

## Parental

1. Press the SETUP button to enter the Setup Menu.
2. Use the ( < , > ) Navigation buttons to select Preference.
3. Use the ( ^ , v ) Navigation buttons to move the cursor to the Parental item.
4. Use the ( > ) Navigation button followed by the ( ^ , v ) Navigation buttons to select one of the 8 rating levels.
5. Press the ENTER button to confirm your desired level.
6. Using the ( < , > , ^ , v ) Navigation buttons and press ENTER to exit and save setting.

e eral	A dio	Dolby	refere ce
refere ce age			
A dio		1 KID AF	
btitle		2	
Di c e		3	
are tal		4 13	
a word		5	
		6	
		7 17	
		8 ADU T	
et are tal o trol			

## Disc Menu

1. Press the SETUP button to enter the Setup Menu.
2. Use the ( < , > ) Navigation buttons to select Preference.
3. Use the ( ^ , v ) Navigation buttons to move the cursor to the Disc Menu item.
4. Use the ( > ) Navigation button followed by the ( ^ , v ) Navigation buttons to select between English, French, Spanish, German, and Japanese Menu languages\*.
5. Press the ENTER button.
6. Using the ( < , > , ^ , v ) Navigation buttons and press ENTER to exit and save setting.



## Password

### Notes:

- The password is factory preset to "1234".

- Press the SETUP button to enter the Setup Menu.
- Use the ( < , > ) Navigation buttons to select Preference.
- Use the ( ^ , v ) Navigation buttons to move the cursor to the Password item.
- Press the Number button(s) to enter a 4-Digit factory preset password "1234" into the the player.
- Press the ENTER button.
- Using the ( < , > , ^ , v ) Navigation buttons and press ENTER to exit and save setting.

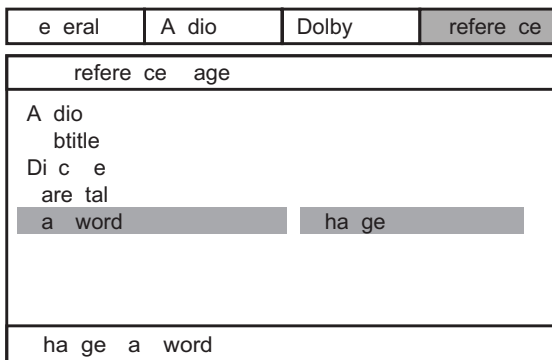

### Notes:

- To change password, enter preset password "1234" and press ENTER button. Use navigation buttons to go back to password box and enter your own 4-digit password and press ENTER button.
- Default function is disabled on the unit. If you forget your own password, enter super password "1369" to unlock control. The password "1369" becomes your password, unless you change it.

## Other Functions

This chapter describes how to use some functions contained in system.

## ZOOM

- Press the ZOOM button to change the size of the screen between 2x, 3x, 4x, and off zoom.

## Common Procedure

- Press the DISPLAY button repeatedly during play to display elapsed time of title, chapter, track, etc.

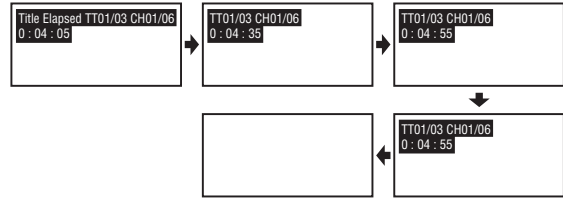

## KEY LOCK

This feature allows you to lock all the controls on the front panel of the main unit to prevent others, especially children, from operating the unit without the remote handset. To activate the Key Lock feature press the KEY LOCK button on the remote control. The "KEY LOCK ON" statement will appear on the TV screen and all front panel controls, including the Power button will be locked. To unlock the front panel controls press the KEY LOCK button on the remote control again. The "KEY LOCK OFF" statement will appear on the TV screen to indicate the unlock action.

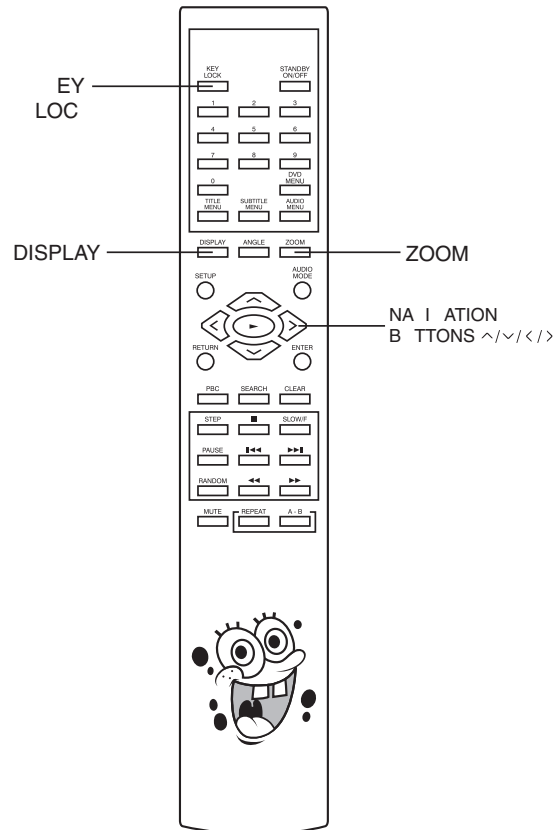



# Additional Information

## Troubleshooting

If you experience any of the following difficulties while using the system, use this troubleshooting guide to help you remedy the problem. Should any problem persist, consult your nearest service center by calling 1-800-898-9020.

### No power.

- Is the power cord firmly plugged into the power outlet?
- One of the safety mechanisms may be operating. In this event, unplug the player from the power outlet briefly and then plug it in again.

### No picture.

- Check that the system is connected securely.
- The video connecting cord is damaged. Replace it with a new one.
- Make sure you connect the system to the video input connector on the TV. (see page 14)
- Make sure you turn on the TV.
- Make sure you select the video input on the TV so that you can view the pictures from this system.

### Noise (interference) appears in the picture.

- Clean the disc.
- If video from this system has to go through your VCR to get to your TV, the copy-protection applied to some DVD programs could affect picture quality.

### The aspect ratio of the screen cannot be changed even though you set "TV SYSTEM" in the SETUP menu when you play a wide picture.

- The aspect rate is fixed on your DVD disc.
- Depending on the TV, you may not be able to change the aspect ratio.

### There is no sound or only a very low-level sound is heard.

- The audio connecting cord is damaged. Replace it with a new one.
- The system is in pause mode or in slow-motion play mode, or fast forward or fast reverse is performed
- Press PLAY (▶) to return to normal play mode.

### Severe hum or noise is heard.

- Move your TV away from the audio components.
- The plugs and jacks are dirty. Wipe them with a cloth slightly moistened with alcohol.
- Clean the disc.

### The remote does not function.

- Remove any obstacles between the remote control and the system.
- Move the remote control closer to the system.
- Point the remote control at the remote sensor on the front panel.
- Replace all the batteries in the remote control with new ones if they are weak.
- Check that the batteries are loaded correctly.

### The disc does not play.

- Insert a disc.
- Insert the disc correctly with the playback side facing down on the disc tray.
- Clean the disc. (see page 12)
- The system cannot play CD-ROMs, etc. (see page 11) Insert a DVD or a CD disc.
- Check the region code of the DVD disc. (see page 11)
- Moisture has condensed inside the system. Remove the disc and leave the system turned on for about an hour. (see page 9)

### The system starts playing the DVD automatically.

- The DVD features the auto playback function.

### Playback stops automatically.

- Depending on the disc, the auto pause signal is recorded. While playing such a disc, the system stops playback at the signal.

### Stopping playback, Search, Slow-motion play, repeat play or Program play, etc., cannot be done.

- Depending on the disc, some of the above operations may not be available.

### Messages do not appear on the TV screen in the language you want.

- Select the language for OSD in SETUP menu. (see page 24) The disc must have the language you selected, if not, other language will be selected.

### The language for the sound cannot be changed when you play a DVD.

- Multilingual sound is not recorded on the DVD.
- Changing the language for the sound is prohibited on the DVD.



## Troubleshooting (Continued)

### The language for the subtitles cannot be changed when you play a DVD.

- Multilingual subtitles are not recorded on the DVD.
- Changing the language for the subtitles is prohibited on the DVD.

### The subtitles cannot be turned off when you play a DVD.

- Depending on the DVD, you may not be able to turn the subtitles off.

### The angles cannot be changed when you play a DVD.

- Multi-angles are not recorded on some DVDs.
- Change the angles when the angle marks appears on the TV screen. (see page 20)
- Changing the angles is prohibited on some DVDs.

### The system does not operate properly.

- Static electricity, etc., may affect the system's operation. Disconnect the AC power cord once, then connect it again.

	<p>TO FIND THE LOCATION AND PHONE NUMBER OF YOUR NEAREST SERVICE CENTER PERMITTED TO PERFORM WARRANTY...</p>
<p>CALL TOLL FREE 1-800-695-0098</p>	
<p>FOR ADDITIONAL SET-UP OR OPERATING ASSISTANCE PLEASE CALL: 1-800-898-9020</p>	
<p>FOR CUSTOMER SERVICE, PLEASE WRITE TO: Emerson Radio Corp. Consumer Affairs Dept. 5101 Statesman Drive, Irving, TX 75063</p>	

The serial number of your system can be found on a label on the back panel of the main unit, and also on the display carton. Please record the serial number in the space below. You may need to refer to this number if your system ever needs to be serviced.

Model No.: SB329

Serial No.: \_\_\_\_\_



## EMERSON RADIO CORP. LIMITED WARRANTY

**What does this warranty cover?** Any manufacturing defects in original material, including original parts and workmanship, under normal use and conditions.

**For how long?** For a period of ninety (90) days for labor and for a period of one (1) year for parts, from the date of original purchase in the U.S.

**What will we do?** If you need service under this warranty, and you provide us with the dated proof of purchase, we will provide repair service at no charge for labor and parts, for the time periods set forth above, at an authorized Depot Repair Facility, or replace the product in our discretion.

**How do you make your warranty claim?** If it becomes necessary to repair your unit, you can obtain the name and mailing location of a Depot Repair Facility by dialing 1-800-695-0098. You should pack your unit in a well-padded heavy corrugated box, enclose your check or money order payable to the Depot Repair Facility in the amount of \$9.00 to cover the return shipping and handling costs, and enclose a copy of your proof of purchase (warranty service will not be provided without a dated proof of purchase).

Finally, you should ship the unit prepaid via UPS or parcel post (insured).

**What does your warranty not cover?** Your warranty does not cover the following:

- Damage from negligence, misuse, abuse, accident, or failure to follow operating instructions.
- Use of product in a commercial application or rentals.
- Changes or repairs by anyone other than an authorized Depot Repair Facility.
- Damage because your unit is improperly connected to the equipment of other manufacturers.
- Unit on which the serial number has been defaced, modified or removed.
- Damage to equipment not properly connected to the product.
- Cost incurred in shipping your unit to and from an authorized Depot Repair Facility.
- Ordinary adjustments which you can perform as outlined in the owner's manual.
- Signal reception problems caused by external antenna or cable systems.
- Products purchased, used, serviced, or damaged outside of the United States.
- Damage to compact discs or cassettes.

**What other limitations apply to your warranty?**

THIS WARRANTY IS NOT-TRANSFERABLE AND APPLIES ONLY TO THE ORIGINAL PURCHASER AND DOES NOT EXTEND TO SUBSEQUENT OWNERS OF THE PRODUCT. THIS WARRANTY IS VALID ONLY IN THE UNITED STATES OF AMERICA. ANY APPLICABLE IMPLIED WARRANTIES, INCLUDING THE WARRANTY OF MERCHANTABILITY, ARE LIMITED IN DURATION TO A PERIOD OF THE EXPRESSED WARRANTY AS PROVIDED ABOVE BEGINNING WITH THE DATE OF ORIGINAL PURCHASE AT RETAIL AND NO WARRANTIES, WHETHER EXPRESSED OR IMPLIED, SHALL APPLY TO THE PRODUCT THERE AFTER. WE MAKE NO WARRANTY AS TO THE FITNESS OF THE PRODUCT FOR ANY PARTICULAR PURPOSE OR USE.

THE EXTENT OF OUR LIABILITY UNDER THIS LIMITED WARRANTY IS THE REPAIR OR REPLACEMENT PROVIDED ABOVE AND IN NO EVENT WILL OUR LIABILITY EXCEED THE PURCHASE PRICE PAID BY THE PURCHASER OF THE PRODUCT. UNDER NO CIRCUMSTANCES WILL WE BE LIABLE FOR ANY LOSS, DIRECT, INDIRECT, INCIDENTAL, SPECIAL, OR CONSEQUENTIAL DAMAGE ARISING OUT OF OR IN CONNECTION WITH THE USE OF THIS PRODUCT.

**How does state law apply to your warranty?**

THIS WARRANTY GIVES YOU SPECIFIC LEGAL RIGHTS, BUT YOU MAY ALSO HAVE OTHER RIGHTS WHICH VARY FROM STATE TO STATE. SOME STATES DO NOT ALLOW LIMITATIONS ON IMPLIED WARRANTIES OR EXCLUSION OR LIMITATION OF INCIDENTAL OR CONSEQUENTIAL DAMAGE, SO THESE RESTRICTIONS MAY NOT APPLY TO YOU.

DVD399



EMERSON  
PART NO.: 21-2069B  
607-02

Printed in China